

Circuit and Electromagnetic System Design Notes

Note 68

24 May 2010

## Options in Microwave Pulse Compression

Carl E. Baum  
University of New Mexico  
Department of Electrical and Computer Engineering  
Albuquerque New Mexico 87131

### Abstract

This paper summarizes the various design considerations for microwave pulse compression for weapon and test facility use.

## 1. Introduction

For about six years now we have been considering various options in designing microwave pulse compressors for weapon and test-facility applications [4-14]. Perhaps it is time to review some approaches to this problem to summarize their advantages and disadvantages.

The basic concept is to construct a high-Q microwave cavity which is pumped up (typically through an iris) from a (relatively) low-power source. This is then switched out to give a microwave pulse of some number of cycles, much less than the number of cycles required from the low-power source to ring up the cavity. Some energy is lost in the process, but the objective is to go to higher power with some number of cycles sufficient to ring up some target resonance to cause circuit upset or even damage [1, 3].

As discussed in [7] the fundamental limitation is given by a gain  $G$  that we wish to maximize. For a length of waveguide as the resonant cavity the optimum coupling gives

$$\begin{aligned} G_c &\approx \frac{4}{\alpha \ell} \text{ (gain in cavity)} \\ \ell &\equiv \text{ waveguide length} \\ \alpha \left( \text{in } e^{-dz} \right) &\equiv \text{attenuation constant (nepers/m) in waveguide fields} \end{aligned} \tag{1.1}$$

This does not include other losses at ends, coupling ports, and switches, but it does point out a limitation. We need a low-loss cavity for high gain.

The foregoing gain relates to power in the cavity, not in the load (say some antenna). So there is a premium to switching out all the energy in as short a time as possible. In general this is governed by the transit time (at group velocity) for all the energy to leave the cavity. This argues for short cavity lengths to maximize  $G_c$ . If wall losses dominate, as long as the minimum required number of cycles is achieved [10]. This gives

$$\begin{aligned} G_o &< G_c \\ G_o &\equiv \text{gain in terms of power to load (G out)} \end{aligned} \tag{1.2}$$

A microwave pulse compressor for our application has multiple components which need to be optimized. Here we summarize, so it is good to have the references handy.

## 2. Closed Waveguides

### 2.1 Standard rectangular waveguide

To date, this is the type of waveguide cavity used in experiments for weapon application [11]. While silver is lower loss than copper for waveguides, it is not that much better. The basic model is as given in (1.1). Noting the electrodynamic scaling with dimensions and frequency,  $f$ , (or wavelength,  $\lambda$ ), we note that the skin-depth phenomenon at the metal surface increases losses as  $f^{1/2}$ . The problem gets more and more difficult as frequency is increased.

### 2.2 Overmoded rectangular waveguide

By increasing waveguide dimensions one enters a regime where multiple modes can propagate. In order to keep the lowest order mode as the only mode one can utilize symmetry and mode suppression techniques [9]. For a fixed frequency, if one doubles the cross section dimensions the losses are roughly halved, approximately doubling the gain (3 db).

There are various problems with such a technique, such as dimensional tolerances. Also one needs to reduce waveguide dimensions near the switch. The output power (toward an antenna) might better be with standard waveguide dimensions (not overmoded).

### 2.3 Low-loss $H_{0,1}$ mode in circular-cylindrical waveguide

This type of waveguide mode is has been used in special applications such as at the VLA (very large array) near Socorro, New Mexico [12]. In that case helically wound copper wire was used so as to support only  $H_{0,n}$  modes, attenuating other kinds. There are also techniques for suppressing  $n > 1$  modes. One also needs to convert this mode into a standard type of (not overmoded) rectangular waveguide for switching out the power. With due care significantly lower loss (compared to standard rectangular waveguide in lowest order mode) can be achieved (like a decade [18]).

### 2.4 Corrugated waveguide

This is a technique to reduce the wall losses by reducing the currents in the walls. What is wanted is a high-surface-impedance boundary as

$$|\tilde{Z}_s(j\omega)| \gg Z_0$$

$$Z_0 = \left[ \frac{\mu_0}{\epsilon_0} \right]^{1/2} \equiv \text{wave impedance of free space} \quad (2.1)$$

One can think of this as a magnetic boundary instead of an electric one. In a waveguide-mode sense we can interchange the roles of electric and magnetic fields [15]. This type of boundary condition can be achieved over a narrow band of frequencies by what is called a corrugated waveguide. Essentially there are troughs in the walls of  $\lambda/4$  or so in depth to give an open-circuit (or highly reactive) impedance to the field at the trough openings into the waveguide.

Some of this is commercially available at high microwave frequencies (>5 GHz) from a company called Antennas for Communications. They call it tallguide, possibly after [15] where “tall waveguide” is introduced. Typically 8 db (a factor of 6.3) improvement (lower loss) is achieved. This seems practical, but may not be enough for some applications.

### 2.5 One or two waveguides leading to output

As discussed in [4, 6] one can pump up the waveguide cavity at various places, but for switching out there are important considerations. One can do this at one end of the waveguide or in the middle, making equivalently two waveguides feeding the output in parallel. With the same total length of waveguide, this gives the option of twice the power in half the pulse width for a differential system.

### 2.6 Some general considerations

The waveguide would need to handle high powers. This is generally not a problem. Standard rectangular waveguide has handled 100 ns, GW pulses at S and X band under high-vacuum conditions! At lower powers air or SF<sub>6</sub> (perhaps pressurized) is also appropriate.

## 3. Open Waveguides

The basic idea here is to get rid of the metal waveguide walls, and thereby the wall loss. Of course this introduces other design problems.

### 3.1 Etalon

This is a French word for a precision wavelength-measuring device based on the Fabry-Perot interferometer [13]. While one can use parallel metal plates (separated by many wavelengths to obtain high Q), a better choice uses spherical concave reflectors. This gives a Gaussian-beam waist between two such metal reflectors. Utilizing symmetry, one can make a half-etalon where the beam waist is intercepted by a microwave horn for connection to the switch and output region. The reflector needs to be large enough to intercept nearly all the power in the Gaussian beam.

At the beam waist one needs to intercept the power in the beam with a microwave horn. For this purpose a corrugated horn is appropriate, not only for its low loss property, but also for its radiation/reception pattern [16]. This pattern is nearly the same in both E and H planes, which is appropriate for Gaussian beams.

Note that this still has the switch and input/output power handled in conventional waveguide, where the losses (per unit length) are larger.

### 3.2 Dielectric waveguide

This is discussed in [14]. A circular cylindrical dielectric rod will guide a wave with no low-frequency cutoff. This is related to the slower propagation speed in the rod as compared to the surrounding medium (air or other gas). This has some similarity to the etalon with the beam being somewhat tighter. We still need to launch and receive the beam, and this will be similar to the etalon case.

## 4. Power Input

Typically one feeds energy into a waveguide cavity through an iris. With an inductive iris the electric fields there are smaller than with a capacitive iris.

There is the question of the optimal iris for feeding the power into the cavity. There is the question of aperture edges [8]. One can also position the iris at various places in the waveguide walls depending on the cavity fields at various locations [6].

## 5. Power Extraction

### 5.1 Positioning a null at the output port

This can be done in various ways. If one couples out through the waveguide side wall [6] ( $\Sigma$  port), then this must be an electric-field null centered on the guide to the side during the charging cycle. This is accomplished

by an appropriate length of guide shorted at some number of half guide wavelengths from the exit port. This shorting plate can take the form of an adjustable plunger (with good sliding contact to the waveguide walls).

Consider two options in Figs. 5.1 and 5.2. In Fig. 5.1 the “tuning port” is taken as the  $\Sigma$  port (magic-tee nomenclature) in the sidewall of the rectangular waveguide. By adjusting the plunger depth one can minimize the power in the output (to the right) in the charging cycle, essentially placing an electric-field null facing the output port (approximately a half guide wavelength from the plunger). However, one can note that there is no symmetry plane to define this electric-field null with respect to the output port.

In Fig. 5.2 we have an alternate approach. Now the  $\Sigma$  port is the output port and the plunger is in the waveguide to the right. As long as the plunger and switch are not too close to the  $\Sigma$  port then evanescent waveguide modes will not be significant in the region of the output port. In this case, neglecting losses, there is a standing wave in the vicinity of the  $\Sigma$  port which is real valued. Then we can think of the plane dividing the  $\Sigma$  port as a symmetry plane for the fields, provided the plunger is appropriately adjusted. The electric field is antisymmetric with respect to this plane as in Fig. 5.2B, thereby not coupling to the symmetric waveguide mode [17] in the output.

Should the iris be far away from the plunger near the output port or in this plunger? This can be understood with the aid of Fig. 5.3. The wave entering from the iris is exponentially attenuated as it propagates away from the iris. It is reflected and attenuates as it propagates back to the iris. The difference between these two waves is maximum at the iris. The difference is minimum near the reflecting plunger. Near this plunger consider the sum and difference of the two waves. The sum can be considered as a standing wave (real valued). The difference can be considered as a traveling wave, but it is small compared to the sum wave near this short circuit. One can then optimally place the output here to minimize the coupling of the difference wave into the output port. Essentially, the field distribution is most like a standing resonant mode near the short, and least like it near the iris.

The short-circuit plunger is optimally positioned near the output to minimize coupling to the output during the charging cycle. To accurately tune to the desired resonant frequency a second plunger near (or even containing) the iris can be employed.

## 5.2 Switch

At approximately a quarter guide wavelength from the short (allowing for switch inductance) there is a switch which shorts between the two broad walls of the waveguide. This switch can be command closed (3-electrode system), or can be self breaking (to obtain more power in the cavity when the switch closes) (Fig. 5.4). The switching medium is typically a gas under appropriate pressure depending on power level.

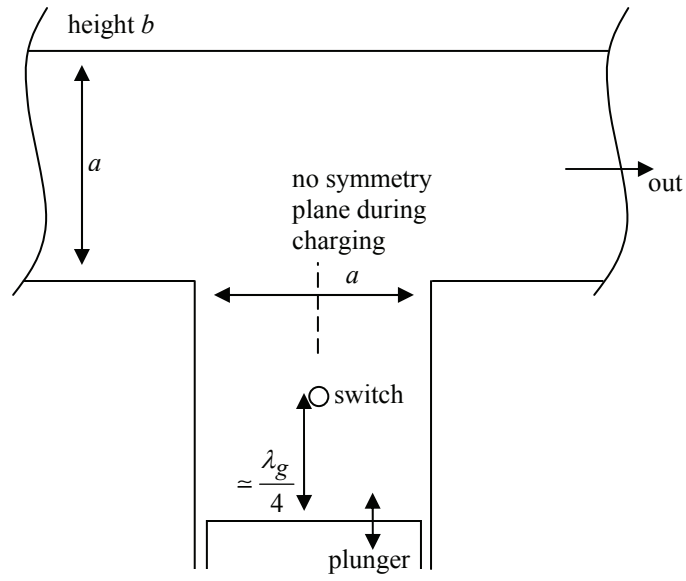
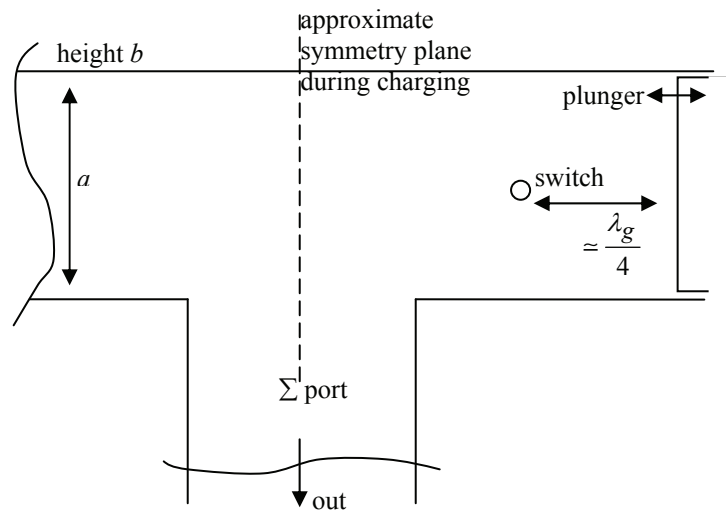
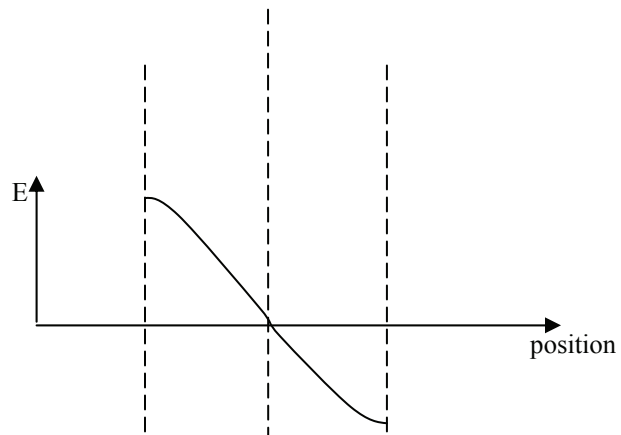

Figure 5.1 Exit Not Through  $\Sigma$  Port



A. Output through  $\Sigma$  port



B. Electric field before switch closure

Fig. 5.2 Symmetry in Output Port.



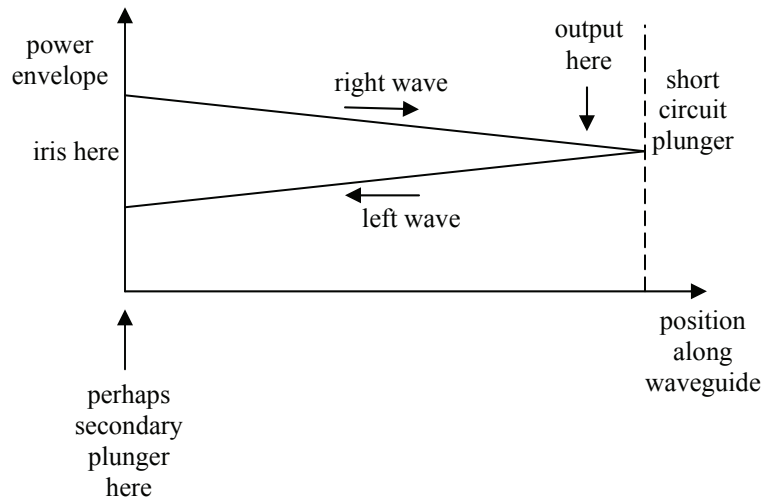
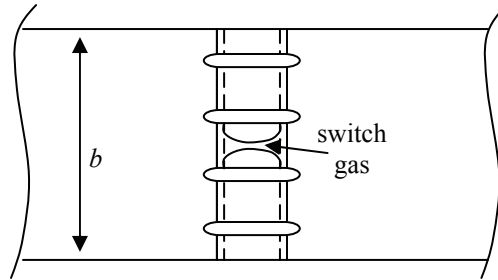
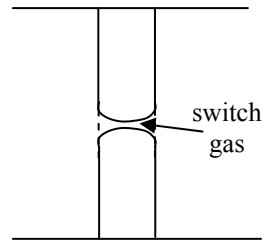

Fig. 5.3 Positioning Output Near Short (Plunger) and Away from Coupling Iris



A. Switch enclosure



B. Self-break version

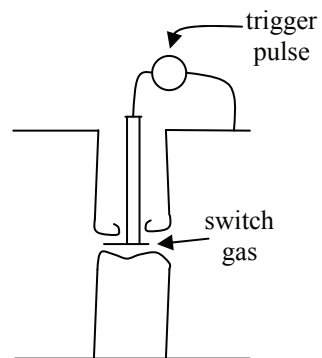

C. Triggered version

Fig. 5.4 Switch Geometry

Various gases can be used. One important gas is pressurized hydrogen. This has shown very fast (100 ps or so) closure times [2] at hundreds of kV.

As illustrated in Fig. 5.4A the enclosure for holding (perhaps pressurized) switch gas needs to avoid surface flash over in the waveguide. This can be improved by including a rib structure which increases the tracking distance. Note the switch position centered in the guide (maximum electric field) which minimizes transit times from switch closure position to the farthest broad wall. While maintaining symmetry, this central position assures an approximate equipotential on which to place the third electrode for a triggered switch as in Fig. 5.4C.

It is important that the switch close in a time short compared to the output pulse width. For a few-cycle pulse this is rather fast, especially for multi-GHz waves. Ideally it should go from open circuit to short circuit in times like a tenth or less of the pulse width.

### 5.3 Impedance matching

Using a magic tee [5] there is an impedance matching requirement at the output of a differential (two-guide) system ( $\Sigma$  port). This can be handled by an appropriate change in the waveguide height (b) for a given width (a) determining the propagation in a rectangular cylindrical guide. One can also use a quarter-wave transformer to match to a standard-height guide. Remember that for maximum power one needs to avoid reflections at the output

In the case of a magic tee the power input can be via an iris into the  $\Delta$  port.

## 6. Concluding Remarks

There are then many questions to be considered in designing an optimum microwave pulse compressor for weapon and/or test facility application. Fundamental is the waveguide/cavity resonator where very low loss is required. Beyond that there are many details to consider.

### References

1. C. E. Baum, "Maximization of Electromagnetic Response at a Distance", Sensor and Simulation Note 312, October 1988; IEEE Trans. EMC, 1992, pp. 148-153.
2. D. V. Giri, H. Lackner, I. D. Smith, D. W. Morton, C. E. Baum, J. R. Marek, D. Scholfield, and W. D. Prather, "A Reflector Antenna for Radiating Impulse-Like Waveforms", Sensor and Simulation Note 382, July 1995; "Design, Fabrication and Testing of a Paraboloidal Reflector Antenna and Pulser System for Impulse-Like Waveforms", IEEE Trans. Plasma Science, 1997, pp. 318-326.

3. C. E. Baum, "A Time-Domain View of Choice of Transient Excitation Waveforms for Enhanced Response of Electronic Systems", *Interaction Note 560*, September 2000; *Proc. ICEAA '01*, Turin, Italy, September 2001, pp. 181-184.
4. C. E. Baum, "Compression of Sinusoidal Pulses for High-Power Microwaves", *Circuit and Electromagnetic System Design Note 48*, March 2004.
5. C. E. Baum, "Impedance-Matched Magic Tee", *Circuit and Electromagnetic System Design Note 51*, March 2006.
6. C. E. Baum, "Coupling Ports in Waveguide Cavities for Multiplying Fields in Pulse-Compression Schemes", *Circuit and Electromagnetic System Design Note 52*, March 2006.
7. A. D. Andreev, E. G. Farr, and E. Schamiloglu, "A Simplified Theory of Microwave Pulse Compression", *Circuit and Electromagnetic System Design Note 57*, August 2008.
8. C. E. Baum, "Raising Cavity Q for Microwave-Pulse Compression by Reducing Aperture Skin-Effect Losses", *Circuit and Electromagnetic System Design Note 60*, June 2009.
9. C. E. Baum, "Increasing Q of Waveguide Pulse-Compression Cavity", *Circuit and Electromagnetic System Design Note 61*, July 2009.
10. C. E. Baum, "Tradeoff Between Pulse Amplitude and Pulse Length From a Microwave-Pulse-Compression Source", *Circuit and Electromagnetic System Design Note 62*, July 2009.
11. E. G. Farr, L. H. Bowen, W. D. Prather, and C. E. Baum, "Microwave Pulse Compression Experiments at Low and High Power", *Circuit and electromagnetic System Design Note 63*, January 2010.
12. C. E. Baum, "Use of the  $H_{0,1}$  Mode in Circular Waveguide for Microwave Pulse Compression", *Circuit and Electromagnetic System Design Note 64*, October 2009.
13. C. E. Baum, "Use of an Etalon as a Microwave Pulse Compressor", *Circuit and Electromagnetic System Design Note 65*, November 2009.
14. C. E. Baum, "A High-Power Dielectric-Rod Resonator for Microwave Pulse Compression", *Circuit and Electromagnetic System Design Note 66*.
15. R. B. Dybdal, L. Peters, Jr., and W. H. Peake, "Rectangular Waveguides with Impedance Walls", *IEEE Trans. MTT-19*, 1971, pp. 2-9.
16. C. A. Balanis, "Horn Antennas", ch. 8, in Y. T. Lo and S. W. Lee, eds., *Antenna Handbook*, Van Nostrand Reinhold, 1988.
17. C. E. Baum and H. N. Kritikos, "Symmetry in Electromagnetics", ch. 1, pp. 1-90, in C. E. Baum and H. N. Kritikos (eds.), *Electromagnetic Symmetry*, Taylor & Francis, 1995.
18. D. M. Pozar, *Microwave Engineering, 2nd. Ed.*, Wiley, 1998.